

# Drawing of waste water treatment plant BioCleaner® BC 6 B

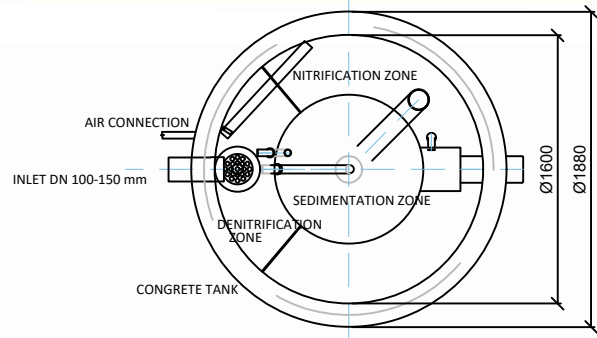

Note: Drawing of WWTP for backfill. Assembly make according to the Instruction for installation.

Volume of denitrification zone	0.50 m <sup>3</sup>	Maximum weight	3650 kg
Volume of nitrification zone	1.18 m <sup>3</sup>	Installed power	50 W
Volume of sedimentation zone	0.63 m <sup>3</sup>	Voltage	230 V
Total volume	2.31 m <sup>3</sup>	Protection of supply cable	4 A
Water level	1.15 m	Supply cabel	CYKY-J3x2.5

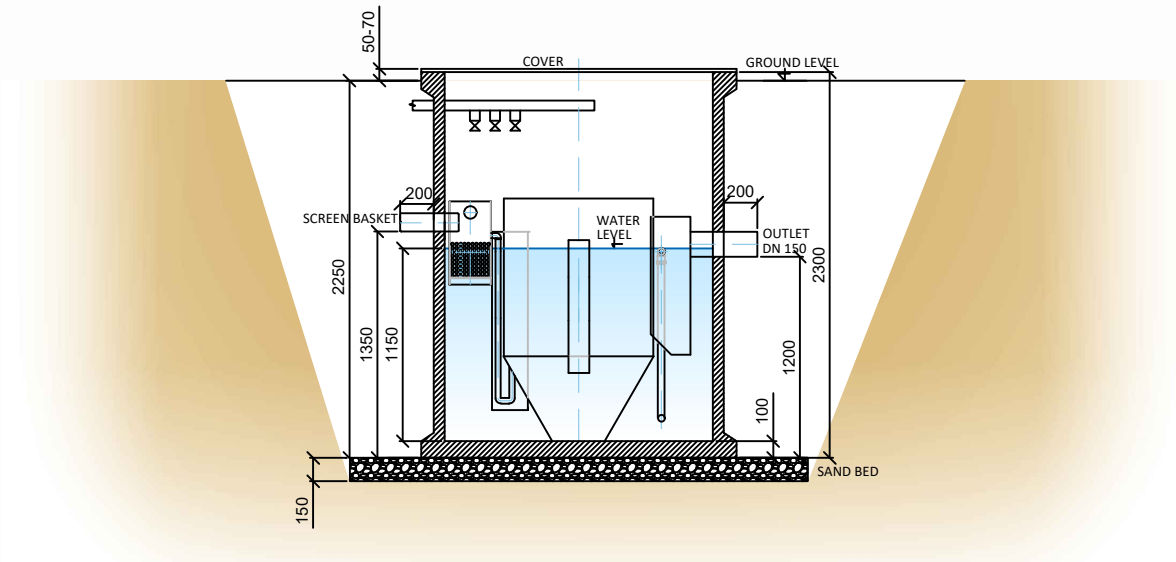