

# Drawing of waste water treatment plant BioCleaner® BC 25 PP

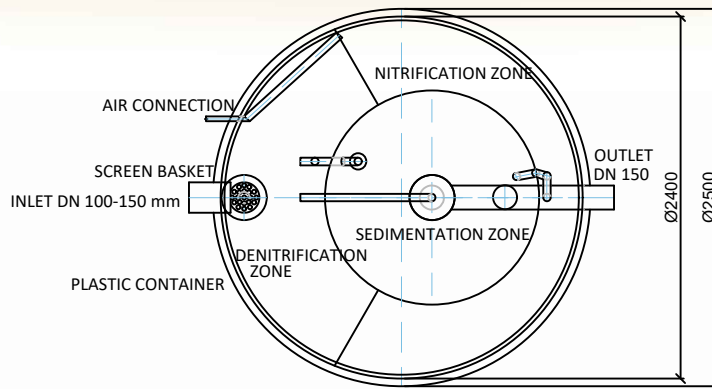
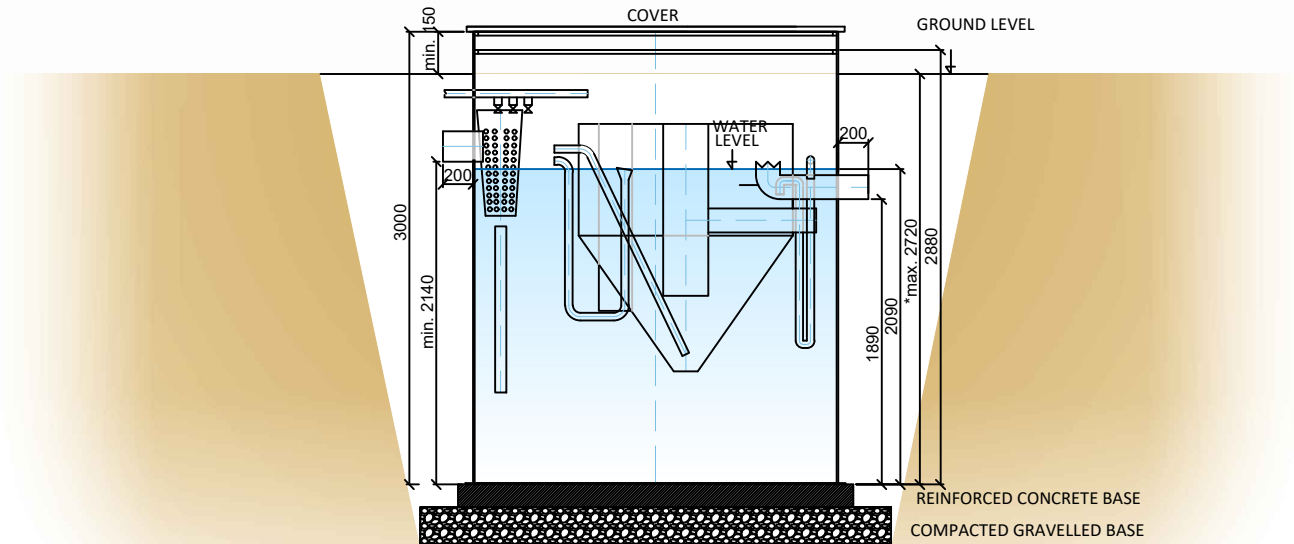

Note: Drawing of WWTP for backfill or concreting. Assembly make according to the Instruction for installation.

\* In case the WWTP has to be installed deeper than maximal allowed dimension (see the drawing) or the soil load around the WWTP or underground water level is higher then we strongly recommend statically secure the WWTP tank (e.g. concreting).

Volume of denitrification zone	2.05 m <sup>3</sup>	Maximum weight	470 kg
Volume of nitrification zone	4.90 m <sup>3</sup>	Installed power	230 W
Volume of sedimentation zone	2.52 m <sup>3</sup>	Voltage	230 V
Total volume	9.47 m <sup>3</sup>	Protection of supply cable	6 A
Water level	2.09 m	Supply cabel	CYKY- J 3x2.5

